

Palo Sofa



Fact Sheet









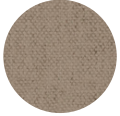

Palo Sofa Single-Seater

Design by Hem Design Studio

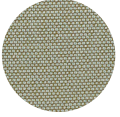
Palo is whatever you want it to be; a chaise, an ottoman, a sofa. This is furniture that evolves and grows with you. Elegant wood and metal legs are a hallmark of the architectural Palo family; as well as providing detail, they are the secret to a modular system that allows cushions and armrests to be moved and repositioned across the whole series. It doesn't end there... Want a side table for your tea? Or need to replace an individual element? Our approach enables you to update and grow your system, adapting to whatever life brings.

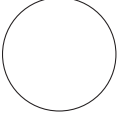

Product name	Finish	SKU
Palo Sofa Single-Seater	Beige	20019
	Blue	12895
	Brown-Black	20010
	Chalk	12918
	Grey	12927
	Jade	20099
	Yellow	20108

<p>Upholstery</p> <p>Amdal by GU (Norway) 70% Virgin Wool, 30% Viscose 100,000 Martindale Pilling 4 Lightfastness 5-7 Flame resistance EN 1021: Part 1 & 2, BS 5852: Part 1 & 2 (Crib 5), US Cal. TB 117</p> <p>Opera by Rohi (Germany) 96% Virgin Wool, 4% Polyamide 90,000 Martindale Pilling 4-5 Lightfastness 5-8 Flame resistance EN 1021: Part 1 & 2, BS 5852: Part 1 & 2 (Crib 5), US Cal. TB 117</p> <p>Leg material</p> <p>Steel Powder Coated</p> <p>Beech Fagus Sylvatica Painted</p> <p>Inside material PU foam Wooden structure</p> <p>Country of origin Poland</p> <p>3D model 3D files of all products are available on the product pages on hem.com</p> <p>Product accessory Palo Side Table</p> <p>Modularity This is a modular product that can be configured freely to fit your needs. Reach out to info@hem.com for assistance</p>	<p>Always in stock We keep all our products in stock and ready to ship from our warehouses in the US and EU</p> <div style="display: grid; grid-template-columns: repeat(4, 1fr); gap: 10px;"> <div style="text-align: center;">  Amdal Beige </div> <div style="text-align: center;">  Amdal Blue </div> <div style="text-align: center;">  Amdal Bown-Black </div> <div style="text-align: center;">  Amdal Chalk </div> <div style="text-align: center;">  Amdal Grey </div> <div style="text-align: center;">  Opera Jade </div> <div style="text-align: center;">  Opera Yellow </div> <div style="text-align: center;">  Powder Coated Steel Steel Blue RAL 5011 </div> <div style="text-align: center;">  Powder Coated Steel Light Grey RAL 7035 </div> <div style="text-align: center;">  Powder Coated Steel Pure White RAL 9010 </div> <div style="text-align: center;">  Powder Coated Steel Jet Black RAL 9005 </div> </div> <p>Samples We supply samples of all our material finishes, order them directly from hem.com/samples</p> <p>COM We offer custom upholsteries and/or stains of this product for larger orders. Reach out to info@hem.com for assistance</p>
---	---

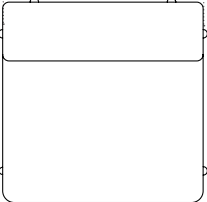
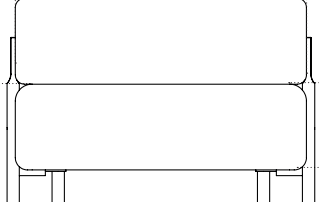
Palo Sofa Single-seater			
Top view	100 cm / 39.4 in		Front view
		97 cm / 38.2 in	95 cm / 37.4 in
			
			67 cm / 26.0 in











Palo Sofa Ottoman

Design by Hem Design Studio

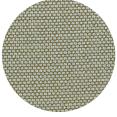
Palo is whatever you want it to be; a chaise, an ottoman, a sofa. This is furniture that evolves and grows with you. Elegant wood and metal legs are a hallmark of the architectural Palo family; as well as providing detail, they are the secret to a modular system that allows cushions and armrests to be moved and repositioned across the whole series. It doesn't end there... Want a side table for your tea? Or need to replace an individual element? Our approach enables you to update and grow your system, adapting to whatever life brings.

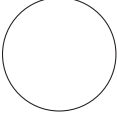

Product name	Finish	SKU
Palo Sofa Ottoman	Beige	20025
	Blue	12938
	Brown-Black	20016
	Chalk	12917
	Grey	12926
	Jade	20105
	Yellow	20114

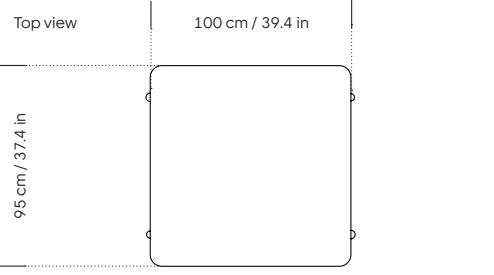
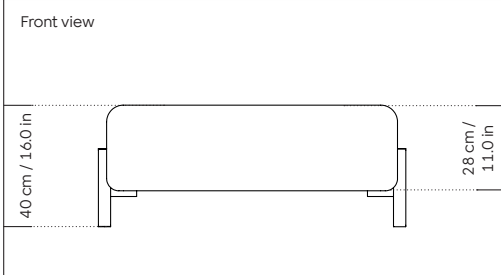
<p>Upholstery</p> <p>Amdal by GU (Norway) 70% Virgin Wool, 30% Viscose 100,000 Martindale Pilling 4 Lightfastness 5-7 Flame resistance EN 1021: Part 1 & 2, BS 5852: Part 1 & 2 (Crib 5), US Cal. TB 117</p> <p>Opera by Rohi (Germany) 96% Virgin Wool, 4% Polyamide 90,000 Martindale Pilling 4-5 Lightfastness 5-8 Flame resistance EN 1021: Part 1 & 2, BS 5852: Part 1 & 2 (Crib 5), US Cal. TB 117</p> <p>Leg material</p> <p>Steel Powder Coated</p> <p>Beech Fagus Sylvatica Painted</p> <p>Inside material PU foam Wooden structure</p> <p>Country of origin Poland</p> <p>3D model 3D files of all products are available on the product pages on hem.com</p> <p>Product accessory Palo Side Table</p> <p>Modularity This is a modular product that can be configured freely to fit your needs. Reach out to info@hem.com for assistance</p>	<p>Always in stock We keep all our products in stock and ready to ship from our warehouses in the US and EU</p> <div style="display: grid; grid-template-columns: repeat(4, 1fr); gap: 10px;"> <div style="text-align: center;">  <p>Amdal Beige</p> </div> <div style="text-align: center;">  <p>Amdal Blue</p> </div> <div style="text-align: center;">  <p>Amdal Bown-Black</p> </div> <div style="text-align: center;">  <p>Amdal Chalk</p> </div> <div style="text-align: center;">  <p>Amdal Grey</p> </div> <div style="text-align: center;">  <p>Opera Jade</p> </div> <div style="text-align: center;">  <p>Opera Yellow</p> </div> <div style="text-align: center;">  <p>Powder Coated Steel Steel Blue RAL 5011</p> </div> <div style="text-align: center;">  <p>Powder Coated Steel Light Grey RAL 7035</p> </div> <div style="text-align: center;">  <p>Powder Coated Steel Pure White RAL 9010</p> </div> <div style="text-align: center;">  <p>Powder Coated Steel Jet Black RAL 9005</p> </div> </div> <p>Samples We supply samples of all our material finishes, order them directly from hem.com/samples</p> <p>COM We offer custom upholsteries and/or stains of this product for larger orders. Reach out to info@hem.com for assistance</p>
Palo Sofa Ottoman	
<p>Top view</p>  <p>95 cm / 37.4 in</p>	<p>Front view</p>  <p>40 cm / 16.0 in</p> <p>28 cm / 11.0 in</p>











Palo Sofa Lounger

Design by Hem Design Studio

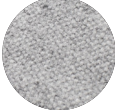
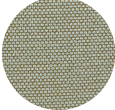
Palo is whatever you want it to be; a chaise, an ottoman, a sofa. This is furniture that evolves and grows with you. Elegant wood and metal legs are a hallmark of the architectural Palo family; as well as providing detail, they are the secret to a modular system that allows cushions and armrests to be moved and repositioned across the whole series. It doesn't end there... Want a side table for your tea? Or need to replace an individual element? Our approach enables you to update and grow your system, adapting to whatever life brings.

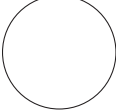

Product name	Finish	SKU
Palo Sofa Lounger	Beige	20024
	Blue	12900
	Brown-Black	20015
	Chalk	12923
	Grey	12932
	Jade	20104
	Yellow	20113

<p>Upholstery</p> <p>Amdal by GU (Norway) 70% Virgin Wool, 30% Viscose 100,000 Martindale Pilling 4 Lightfastness 5-7 Flame resistance EN 1021: Part 1 & 2, BS 5852: Part 1 & 2 (Crib 5), US Cal. TB 117</p> <p>Opera by Rohi (Germany) 96% Virgin Wool, 4% Polyamide 90,000 Martindale Pilling 4-5 Lightfastness 5-8 Flame resistance EN 1021: Part 1 & 2, BS 5852: Part 1 & 2 (Crib 5), US Cal. TB 117</p> <p>Leg material</p> <p>Steel Powder Coated</p> <p>Beech Fagus Sylvatica Painted</p> <p>Inside material PU foam Wooden structure</p> <p>Country of origin Poland</p> <p>3D model 3D files of all products are available on the product pages on hem.com</p> <p>Product accessory Palo Side Table</p> <p>Modularity This is a modular product that can be configured freely to fit your needs. Reach out to info@hem.com for assistance</p>	<p>Always in stock We keep all our products in stock and ready to ship from our warehouses in the US and EU</p> <div style="display: grid; grid-template-columns: repeat(4, 1fr); gap: 10px;"> <div style="text-align: center;">  Amdal Beige </div> <div style="text-align: center;">  Amdal Blue </div> <div style="text-align: center;">  Amdal Bown-Black </div> <div style="text-align: center;">  Amdal Chalk </div> <div style="text-align: center;">  Amdal Grey </div> <div style="text-align: center;">  Opera Jade </div> <div style="text-align: center;">  Opera Yellow </div> <div style="text-align: center;">  Powder Coated Steel Steel Blue RAL 5011 </div> <div style="text-align: center;">  Powder Coated Steel Light Grey RAL 7035 </div> <div style="text-align: center;">  Powder Coated Steel Pure White RAL 9010 </div> <div style="text-align: center;">  Powder Coated Steel Jet Black RAL 9005 </div> </div> <p>Samples We supply samples of all our material finishes, order them directly from hem.com/samples</p> <p>COM We offer custom upholsteries and/or stains of this product for larger orders. Reach out to info@hem.com for assistance</p>
---	---

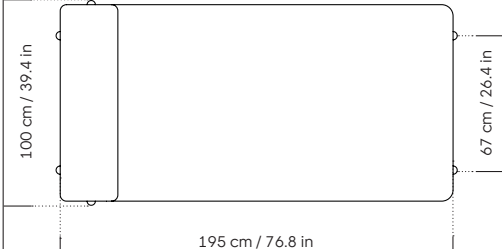
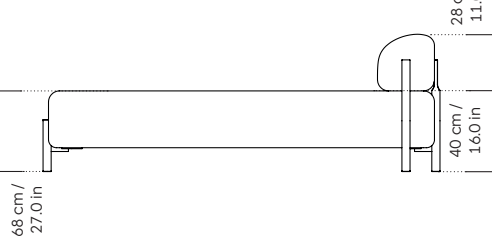
Palo Sofa Lounger	
Top view	Front view
	









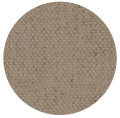

Palo Sofa 2-Seater

Design by Hem Design Studio

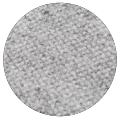
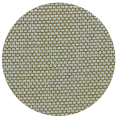
Palo is whatever you want it to be; a chaise, an ottoman, a sofa. This is furniture that evolves and grows with you. Elegant wood and metal legs are a hallmark of the architectural Palo family; as well as providing detail, they are the secret to a modular system that allows cushions and armrests to be moved and repositioned across the whole series. It doesn't end there... Want a side table for your tea? Or need to replace an individual element? Our approach enables you to update and grow your system, adapting to whatever life brings.

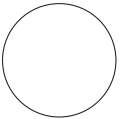

Product name	Finish	SKU
Palo Sofa 2-Seater	Beige	20021
	Blue	12897
	Brown-Black	20012
	Chalk	12920
	Grey	12929
	Jade	20101
	Yellow	20110

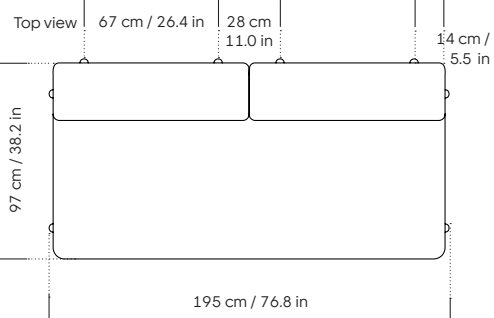
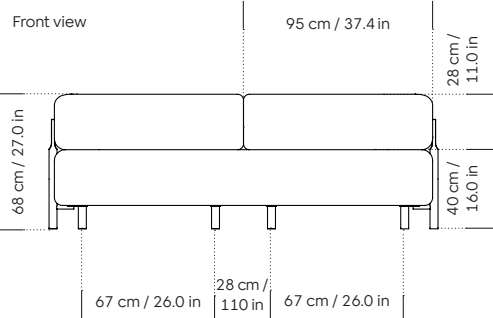
<p>Upholstery</p> <p>Amdal by GU (Norway) 70% Virgin Wool, 30% Viscose 100,000 Martindale Pilling 4 Lightfastness 5-7 Flame resistance EN 1021: Part 1 & 2, BS 5852: Part 1 & 2 (Crib 5), US Cal. TB 117</p> <p>Opera by Rohi (Germany) 96% Virgin Wool, 4% Polyamide 90,000 Martindale Pilling 4-5 Lightfastness 5-8 Flame resistance EN 1021: Part 1 & 2, BS 5852: Part 1 & 2 (Crib 5), US Cal. TB 117</p> <p>Leg material</p> <p>Steel Powder Coated</p> <p>Beech Fagus Sylvatica Painted</p> <p>Inside material PU foam Wooden structure</p> <p>Country of origin Poland</p> <p>3D model 3D files of all products are available on the product pages on hem.com</p> <p>Product accessory Palo Side Table</p> <p>Modularity This is a modular product that can be configured freely to fit your needs. Reach out to info@hem.com for assistance</p>	<p>Always in stock We keep all our products in stock and ready to ship from our warehouses in the US and EU</p> <div style="display: grid; grid-template-columns: repeat(4, 1fr); gap: 10px;"> <div style="text-align: center;">  <p>Amdal Beige</p> </div> <div style="text-align: center;">  <p>Amdal Blue</p> </div> <div style="text-align: center;">  <p>Amdal Bown-Black</p> </div> <div style="text-align: center;">  <p>Amdal Chalk</p> </div> <div style="text-align: center;">  <p>Amdal Grey</p> </div> <div style="text-align: center;">  <p>Opera Jade</p> </div> <div style="text-align: center;">  <p>Opera Yellow</p> </div> <div style="text-align: center;">  <p>Powder Coated Steel Steel Blue RAL 5011</p> </div> <div style="text-align: center;">  <p>Powder Coated Steel Light Grey RAL 7035</p> </div> <div style="text-align: center;">  <p>Powder Coated Steel Pure White RAL 9010</p> </div> <div style="text-align: center;">  <p>Powder Coated Steel Jet Black RAL 9005</p> </div> </div> <p>Samples We supply samples of all our material finishes, order them directly from hem.com/samples</p> <p>COM We offer custom upholsteries and/or stains of this product for larger orders. Reach out to info@hem.com for assistance</p>
<p>Palo Sofa 2-seater</p> <div style="display: flex; justify-content: space-between;"> <div style="text-align: center;"> <p>Top view</p>  <p>195 cm / 76.8 in</p> </div> <div style="text-align: center;"> <p>Front view</p>  </div> </div>	







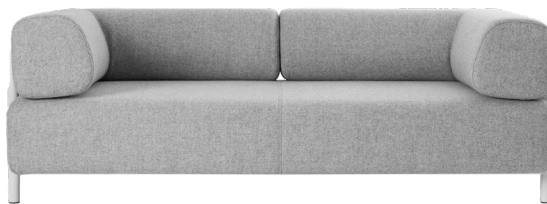

Palo Sofa 2-Seater + Armrests

Design by Hem Design Studio

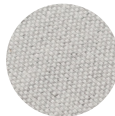
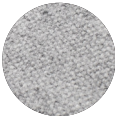
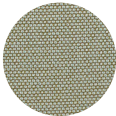
Palo is whatever you want it to be; a chaise, an ottoman, a sofa. This is furniture that evolves and grows with you. Elegant wood and metal legs are a hallmark of the architectural Palo family; as well as providing detail, they are the secret to a modular system that allows cushions and armrests to be moved and repositioned across the whole series. It doesn't end there... Want a side table for your tea? Or need to replace an individual element? Our approach enables you to update and grow your system, adapting to whatever life brings.

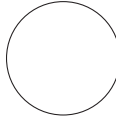

Product name	Finish	SKU
Palo Sofa 2-Seater + Armrests	Beige	20020
	Blue	12896
	Brown-Black	20011
	Chalk	12919
	Grey	12928
	Jade	20100
	Yellow	20109

<p>Upholstery</p> <p>Amdal by GU (Norway) 70% Virgin Wool, 30% Viscose 100,000 Martindale Pilling 4 Lightfastness 5-7 Flame resistance EN 1021: Part 1 & 2, BS 5852: Part 1 & 2 (Crib 5), US Cal. TB 117</p> <p>Opera by Rohi (Germany) 96% Virgin Wool, 4% Polyamide 90,000 Martindale Pilling 4-5 Lightfastness 5-8 Flame resistance EN 1021: Part 1 & 2, BS 5852: Part 1 & 2 (Crib 5), US Cal. TB 117</p> <p>Leg material</p> <p>Steel Powder Coated</p> <p>Beech Fagus Sylvatica Painted</p> <p>Inside material PU foam Wooden structure</p> <p>Country of origin Poland</p> <p>3D model 3D files of all products are available on the product pages on hem.com</p> <p>Product accessory Palo Side Table</p> <p>Modularity This is a modular product that can be configured freely to fit your needs. Reach out to info@hem.com for assistance</p>	<p>Always in stock We keep all our products in stock and ready to ship from our warehouses in the US and EU</p> <div style="display: grid; grid-template-columns: repeat(4, 1fr); gap: 10px;"> <div style="text-align: center;">  <p>Amdal Beige</p> </div> <div style="text-align: center;">  <p>Amdal Blue</p> </div> <div style="text-align: center;">  <p>Amdal Bown-Black</p> </div> <div style="text-align: center;">  <p>Amdal Chalk</p> </div> <div style="text-align: center;">  <p>Amdal Grey</p> </div> <div style="text-align: center;">  <p>Opera Jade</p> </div> <div style="text-align: center;">  <p>Opera Yellow</p> </div> <div style="text-align: center;">  <p>Powder Coated Steel Steel Blue RAL 5011</p> </div> <div style="text-align: center;">  <p>Powder Coated Steel Light Grey RAL 7035</p> </div> <div style="text-align: center;">  <p>Powder Coated Steel Pure White RAL 9010</p> </div> <div style="text-align: center;">  <p>Powder Coated Steel Jet Black RAL 9005</p> </div> </div> <p>Samples We supply samples of all our material finishes, order them directly from hem.com/samples</p> <p>COM We offer custom upholsteries and/or stains of this product for larger orders. Reach out to info@hem.com for assistance</p>
---	---

Palo Sofa 2-seater + Armrests	
Top view	67 cm / 26.4 in 28 cm / 11.0 in 14 cm / 5.5 in 97 cm / 38.2 in 67 cm / 26.4 in
Front view	95 cm / 37.4 in 28 cm / 11.0 in 40 cm / 16.0 in 68 cm / 27.0 in 67 cm / 26.0 in 28 cm / 11.0 in 67 cm / 26.0 in
195 cm / 76.8 in	

Palo Sofa 2-Seater Chaise Left & Palo Sofa 2-Seater Chaise Right

Design by Hem Design Studio

Palo is whatever you want it to be; a chaise, an ottoman, a sofa. This is furniture that evolves and grows with you. Elegant wood and metal legs are a hallmark of the architectural Palo family; as well as providing detail, they are the secret to a modular system that allows cushions and armrests to be moved and repositioned across the whole series. It doesn't end there... Want a side table for your tea? Or need to replace an individual element? Our approach enables you to update and grow your system, adapting to whatever life brings.



Product name	Finish	SKU
Palo Sofa 2-Seater Chaise Left	Beige	20022
	Blue	12898
	Brown-Black	20013
	Chalk	12921
	Grey	12930
	Jade	20102
	Yellow	20111
Palo Sofa 2-Seater Chaise Right	Beige	20023
	Blue	12899
	Brown-Black	20014
	Chalk	12922
	Grey	12931
	Jade	20103
	Yellow	20112

Upholstery

Amdal

by GU (Norway)
70% Virgin Wool, 30% Viscose
100,000 Martindale
Pilling 4
Lightfastness 5-7
Flame resistance EN 1021: Part 1 & 2, BS 5852: Part 1 & 2 (Crib 5), US Cal. TB 117

Opera

by Rohi (Germany)
96% Virgin Wool, 4% Polyamide
90,000 Martindale
Pilling 4-5
Lightfastness 5-8
Flame resistance EN 1021: Part 1 & 2, BS 5852: Part 1 & 2 (Crib 5), US Cal. TB 117

Leg material

Steel

Powder Coated

Beech

Fagus Sylvatica
Painted

Inside material

PU foam
Wooden structure

Country of origin

Poland

3D model

3D files of all products are available on the product pages on hem.com

Product accessory

Palo Side Table

Modularity

This is a modular product that can be configured freely to fit your needs. Reach out to info@hem.com for assistance

Always in stock

We keep all our products in stock and ready to ship from our warehouses in the US and EU



Amdal
Beige



Amdal
Blue



Amdal
Brown-Black



Amdal
Chalk

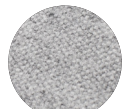

Amdal
Grey

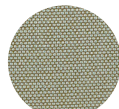

Opera
Jade

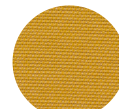

Opera
Yellow



Powder Coated Steel
Steel Blue RAL 5011



Powder Coated Steel
Light Grey RAL 7035

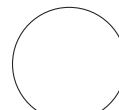

Powder Coated Steel
Pure White RAL 9010



Powder Coated Steel
Jet Black RAL 9005

Samples

We supply samples of all our material finishes, order them directly from hem.com/samples

COM

We offer custom upholsteries and/or stains of this product for larger orders. Reach out to info@hem.com for assistance

Palo Sofa 2-seater Chaise

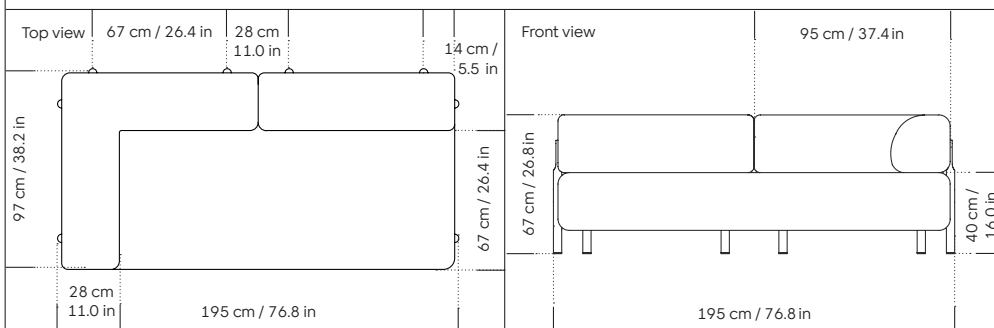

Palo Sofa Corner Left & Palo Sofa Corner Right

Design by Hem Design Studio

Palo is whatever you want it to be; a chaise, an ottoman, a sofa. This is furniture that evolves and grows with you. Elegant wood and metal legs are a hallmark of the architectural Palo family; as well as providing detail, they are the secret to a modular system that allows cushions and armrests to be moved and repositioned across the whole series. It doesn't end there... Want a side table for your tea? Or need to replace an individual element? Our approach enables you to update and grow your system, adapting to whatever life brings.



Product name	Finish	SKU
Palo Sofa Corner Left	Beige	20027
	Blue	12954
	Brown-Black	20018
	Chalk	12956
	Grey	12958
	Jade	20107
	Yellow	20116
Palo Sofa Corner Right	Beige	20026
	Blue	12953
	Brown-Black	20017
	Chalk	12955
	Grey	12957
	Jade	20106
	Yellow	20115

Upholstery

Amdal

by GU (Norway)
70% Virgin Wool, 30% Viscose
100,000 Martindale
Pilling 4
Lightfastness 5-7
Flame resistance EN 1021: Part 1 & 2, BS 5852: Part 1 & 2 (Crib 5), US Cal. TB 117

Opera

by Rohi (Germany)
96% Virgin Wool, 4% Polyamide
90,000 Martindale
Pilling 4-5
Lightfastness 5-8
Flame resistance EN 1021: Part 1 & 2, BS 5852: Part 1 & 2 (Crib 5), US Cal. TB 117

Leg material

Steel

Powder Coated

Beech

Fagus Sylvatica
Painted

Inside material

PU foam
Wooden structure

Country of origin

Poland

3D model

3D files of all products are available on the product pages on hem.com

Product accessory

Palo Side Table

Modularity

This is a modular product that can be configured freely to fit your needs. Reach out to info@hem.com for assistance

Always in stock

We keep all our products in stock and ready to ship from our warehouses in the US and EU



Amdal
Beige



Amdal
Blue



Amdal
Bown-Black

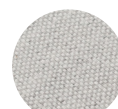

Amdal
Chalk

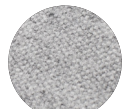

Amdal
Grey

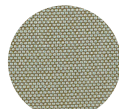

Opera
Jade

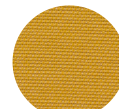

Opera
Yellow



Powder Coated Steel
Steel Blue RAL 5011



Powder Coated Steel
Light Grey RAL 7035

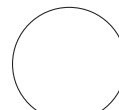

Powder Coated Steel
Pure White RAL 9010



Powder Coated Steel
Jet Black RAL 9005

Samples

We supply samples of all our material finishes, order them directly from hem.com/samples

COM

We offer custom upholsteries and/or stains of this product for larger orders. Reach out to info@hem.com for assistance

Palo Sofa Corner

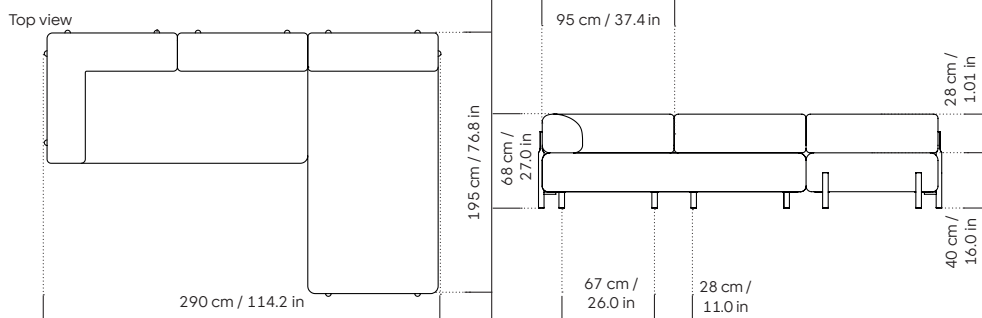

With proper care, the high quality of Hem furniture can be maintained for years to come. If you want to learn more or have any questions about our care & maintenance recommendations, please write to info@hem.com.

Hem