

Kumo Sofa + Armrests

by Anderssen & Voll

A ship-smart modular system by Norwegian designers Anderssen & Voll, the Kumo Sofa is available in three texture-rich woolen fabrics – Mare, Graphite and Porcelain. Based on a single module, Kumo can be configured as a 1,2,3,4-seater and beyond. Kumo offers flexibility with an innovative frame and cushion construction allowing components to easily be added, removed or rearranged as your living circumstances change.

The Kumo Sofa parts

Please note: The exact number
of the parts in your package
vary with each Kumo configuration.



knob

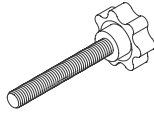

screw



plastic fitting

top

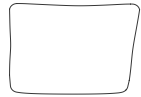
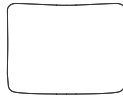
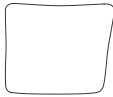
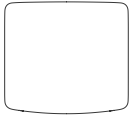

side

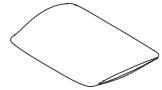
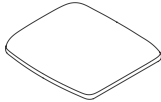

seats

armrest

middle backrest

side backrest

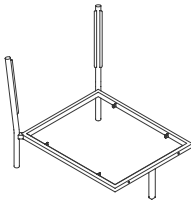

End frame

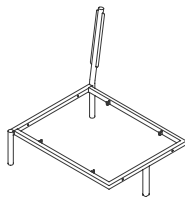

extension frame

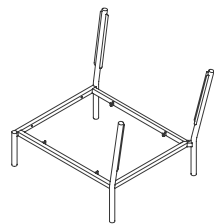

start frame

Building the Kumo 3-Seater + Armrests

Please note: The Kumo 3-Seater + Armrests consists of a Kumo 2-Seater + Armrests and an extension frame, The Kumo 4-Seater + Armrests consists of a Kumo 2-Seater + Armrests and two extension frames.

1

Starting with the start frame, the right hand side of the final sofa,
click in all the plastic fittings with the help of a screw driver,
in case they're not in place.

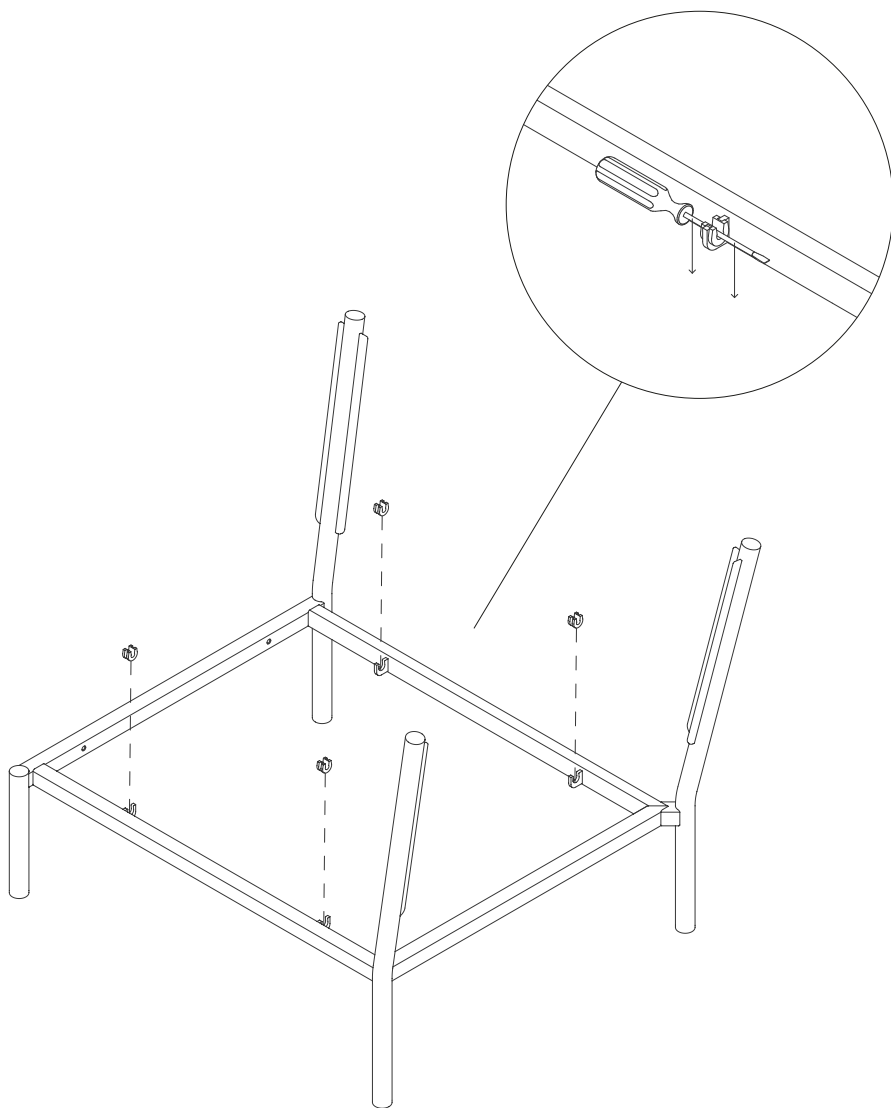

2

Attach the extension frame to the start frame by using the screws provided as seen on the picture below. Repeat the same process with the last frame, the end frame, until your sofa frame looks ready assembled.

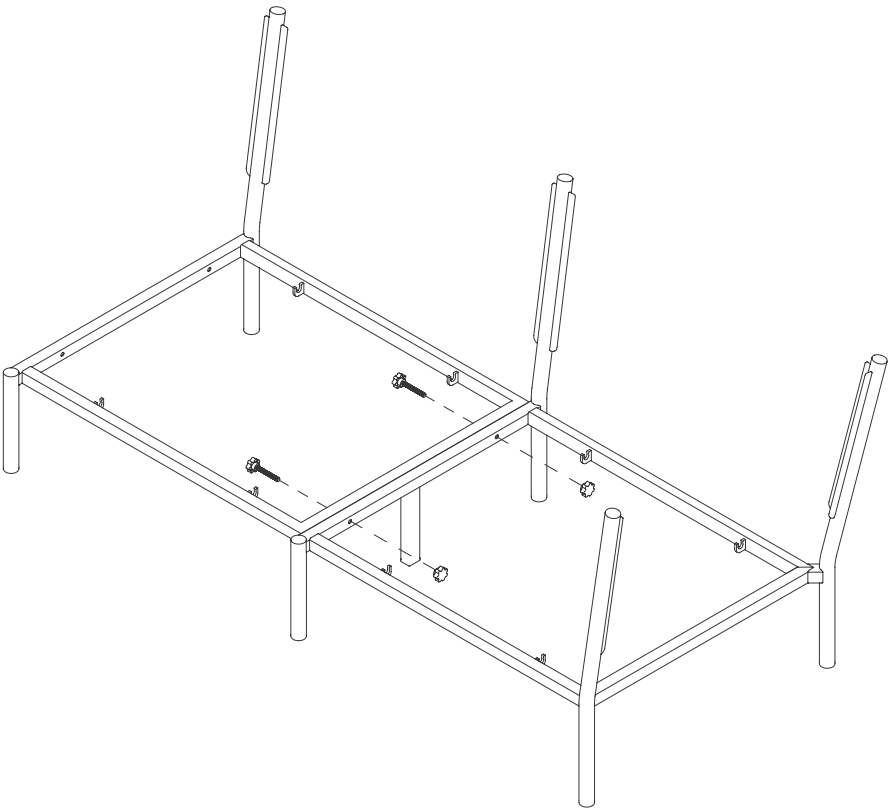

3

Next, click the seat cushions into the frame.
When you hear a click sound, the cushions sit tightly in the frame.
Use your knee for more force.

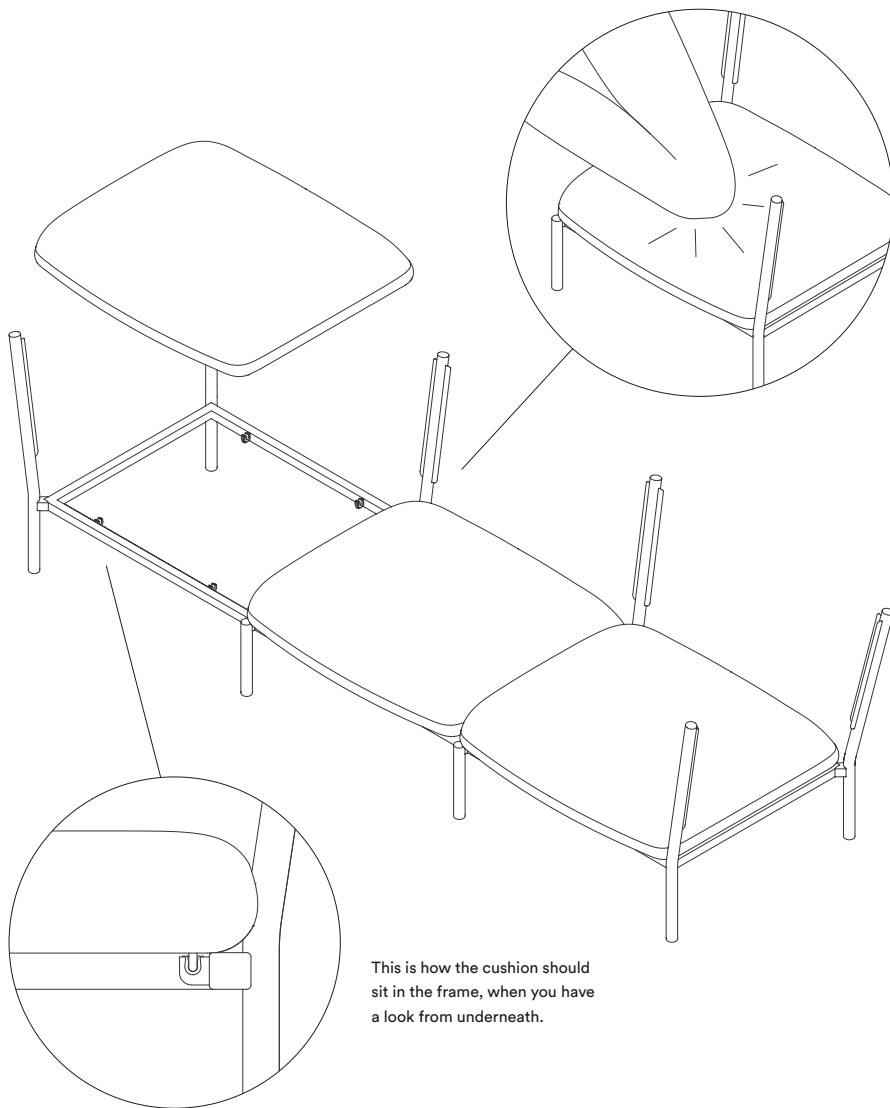

4

Your Kumo Sofa should now look like this from the top.
Double check, that you have clicked the seats in correctly
and facing the right way.

Back

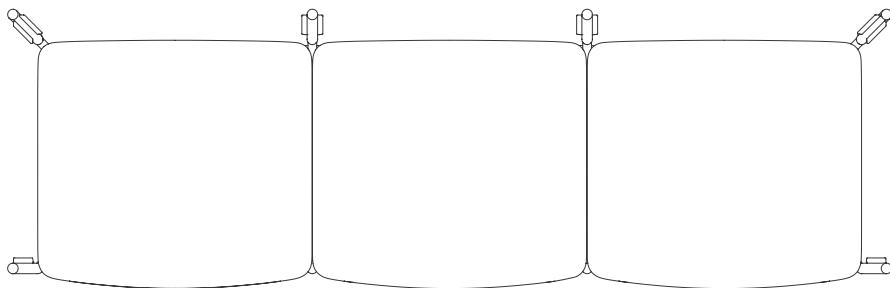

Front

5

Next, slide the armrest cushions into the outside slots of the frame. Make sure the cushions are placed correctly, as below:

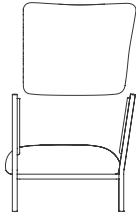

Correct

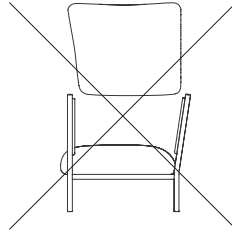

Incorrect

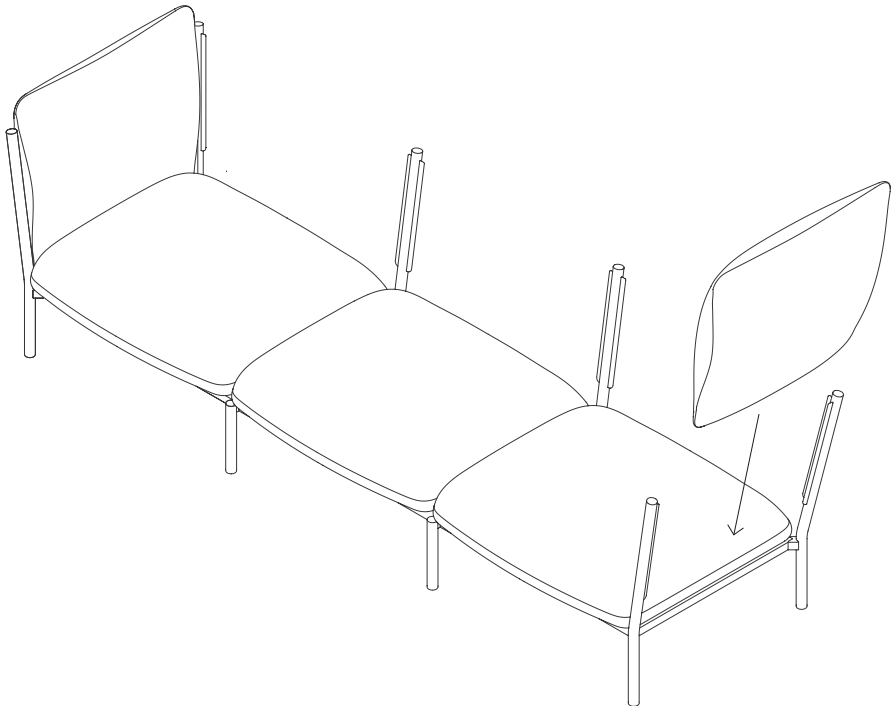

6

After that, slide in the side backrest cushions. Start from left to right for easiest assembly. Make sure the cushions are placed correctly, as below:

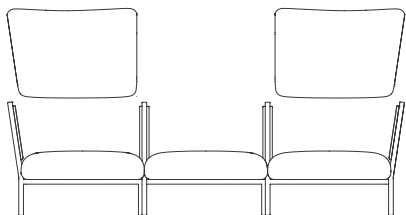

Correct

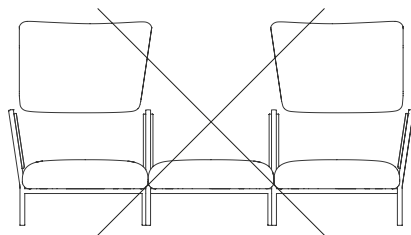

Incorrect

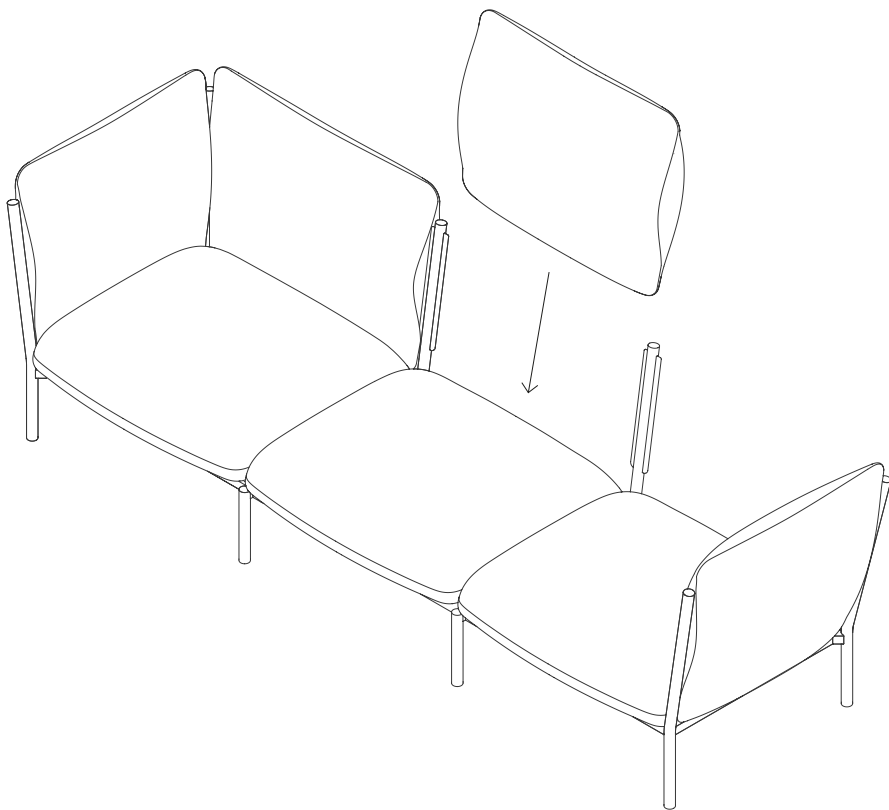

7

Lastly, slide in the right outer backrest cushion.

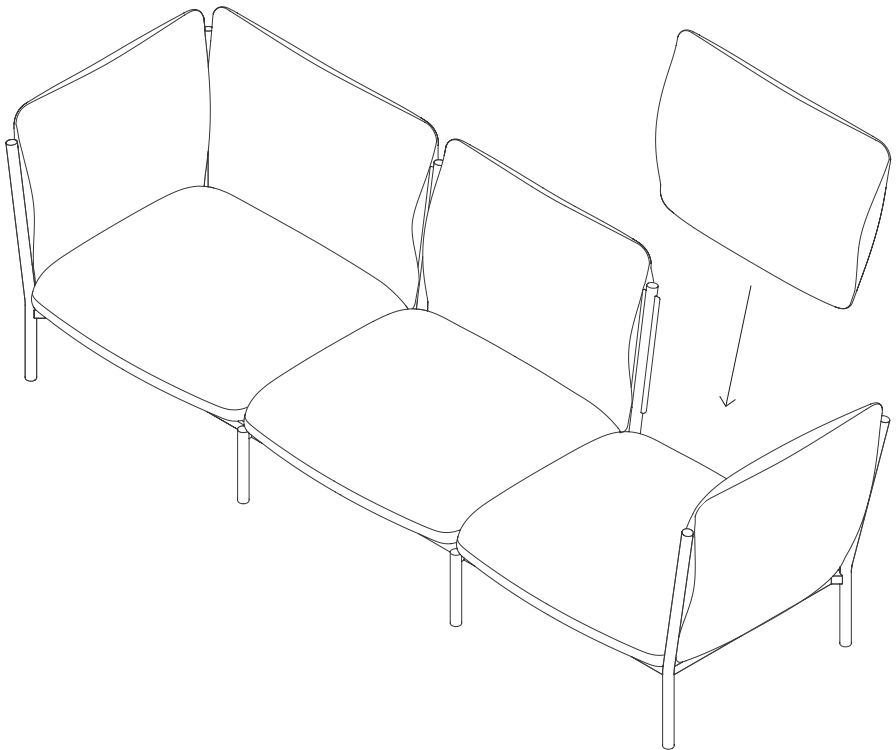

8

Your Kumo Sofa is now ready assembled!

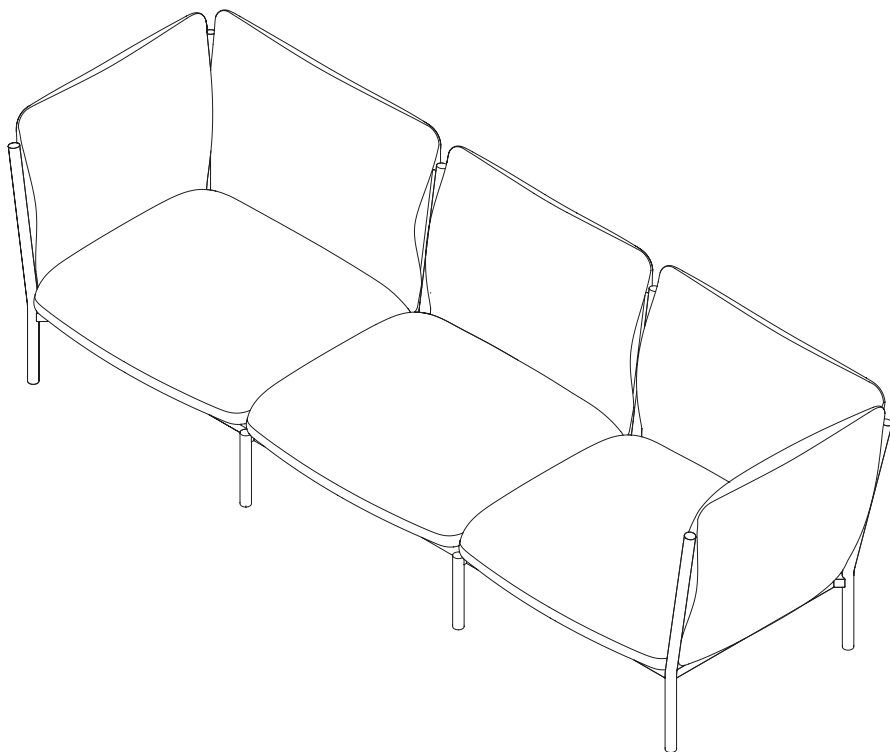

?

Should you have any problems assembling your
product, contact us at info@hem.com.

We're always happy to help!

hem

hem.com